



MOTORTRONICS™

Solid State AC Motor Control

Msmart

MV addendum w/MVC4-SMART-TCB



GEN 3 224R2

Table of contents

- 1 About the Msmart.....3**
 - 1.1 General3
 - 1.2 Dimensions.....4
 - 1.3 Msmart Configuration.....5

- 2 Connecting Auxiliary Devices6**
 - 2.1 Connecting Msmart to Smart TCB.....6
 - 2.2 Connecting RX Motor Protection Relays6
 - 2.3 Connecting TE-RTD12 Motor RTD Modules.....7

- 3 Msmart Touch Screen8**
 - 3.1 Startup.....8
 - 3.2 Navigation and Settings10
 - 3.2.1 Main Menu10
 - 3.2.2 MVC Status / Setup Screen.....11
 - 3.2.3 Msmart Settings12
 - 3.3 Device Selection and Programming13
 - 3.3.1 Device Selection13
 - 3.3.2 MVC4 Programming.....14
 - 3.3.3 RX Programming.....18
 - 3.3.4 TE-RTD12 Programming.....21

- APPENDIX A: TECHNICAL SPECIFICATIONS24**

- WARRANTY INFORMATION25**

1. About Msmart

1.1 General / Features

Msmart is a unified screen for all Motortronics products and consists of an active touch screen / information display. In addition, Msmart supports multiple languages and supports dedicated information and graphs for each product. Msmart also has built-in an auto sleep function with wake-up on motion.

Features

- Color Touch Panel
- Hardware Pushbuttons for Harsh Environments
- Auto Sleep Function with Motion Sensing
- Support for 6 Languages
- Unified Touchscreen for all Motortronics Products
- Virtual MVC Keypad

Available Information / Graphs

- Operation Status
- Starting Current Graph
- Bar Graph for RTD Temperatures
- Three Phase Voltage / Current Information
- Relay Status
- RX and TE-RTD12 Interface

Compatible with

- MVC4 Medium Voltage Soft Starter
- VMX Low Voltage Solid State Soft Starter
- VMX S.A.F.E. Series
- VMX NEMA Series
- VMX-synergy Series
- Smart TCB
- RX Series Motor Protection Relay
- TE-RTD12 Motor RTD Relay

1.2 Dimensions

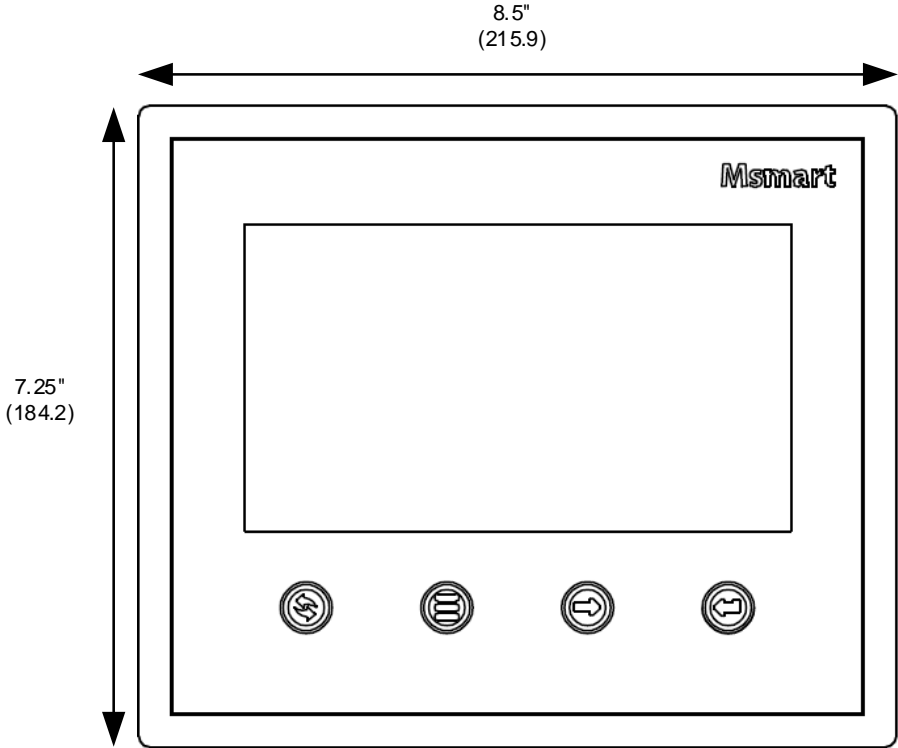

8.5" x 7.25" x 1.75" (H x W x D)
215.9 mm x 184.3 mm x 44.5 mm (H x W x D) (mm)

1.3 Msmart Configuration

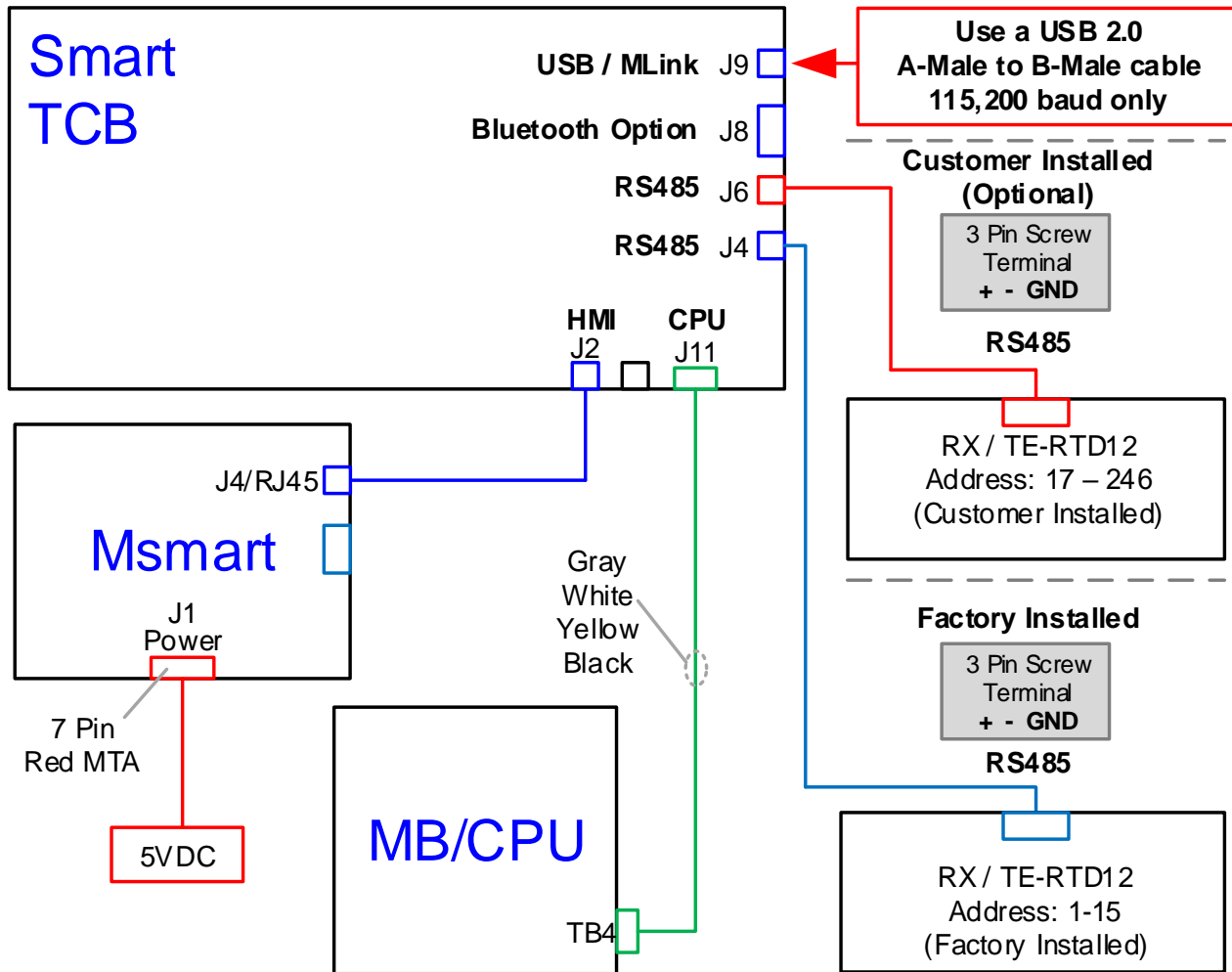

Msmart connection diagram to Smart TCB, MVC4 Medium Voltage Soft Starter, RX Motor Protection Relays and TE-RTD12 Motor RTD Monitor Devices.

2. Connecting Auxiliary Devices

The next steps describe how to connect devices to Msmart and Smart TCB

2.1 Connecting Msmart to the Smart TCB Board

Connect RJ45 cable between connector J11 of the Smart TCB board and TB4 of the Msmart panel.

2.2 Connecting RX Motor Protection Relays

Use shielded cable to connect the RX to the Smart TCB

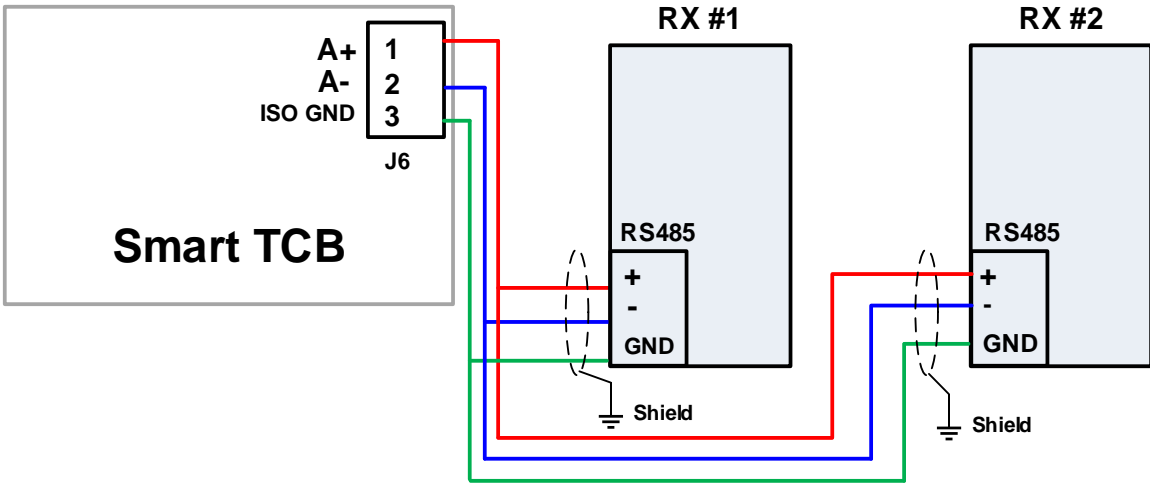

J6 Port:

RS485, 3 terminals, Non-isolated
 Protocol: Modbus RTU
 Device Address: Range 17-246
 Baud Rate: 19200
 Pin 1 = S+, Pin 2 = S-, Pin 3 = GND

Note: Maximum number of RX units (Factory installed + Customer installed) is 2.

Communication Settings

Parameter	Description	Settings / Range	Default RX #1	Default RX #2
F072	Password	0 – 9999	2000	2000
F060	Communications	Range: 0 – 4 0 = Disabled 1 = Enabled (11 bit format) 2 = Enabled (10 bit format) 3 = Enabled (11 bit) and Remote Start Control; 4 = Enabled (10 bit) and Remote Start Control.	2	2
F061	Baud Rate	4.8, 9.6 and 19.2 KB Note: Msmart only supports 19.2 kB	19.2	19.2
F062	Modbus Address	1 - 247	17-246	17-246

2.3 Connecting TE-RTD12 Motor RTD Devices

Use shielded cable to connect the TE-RTD12 to the Smart TCB

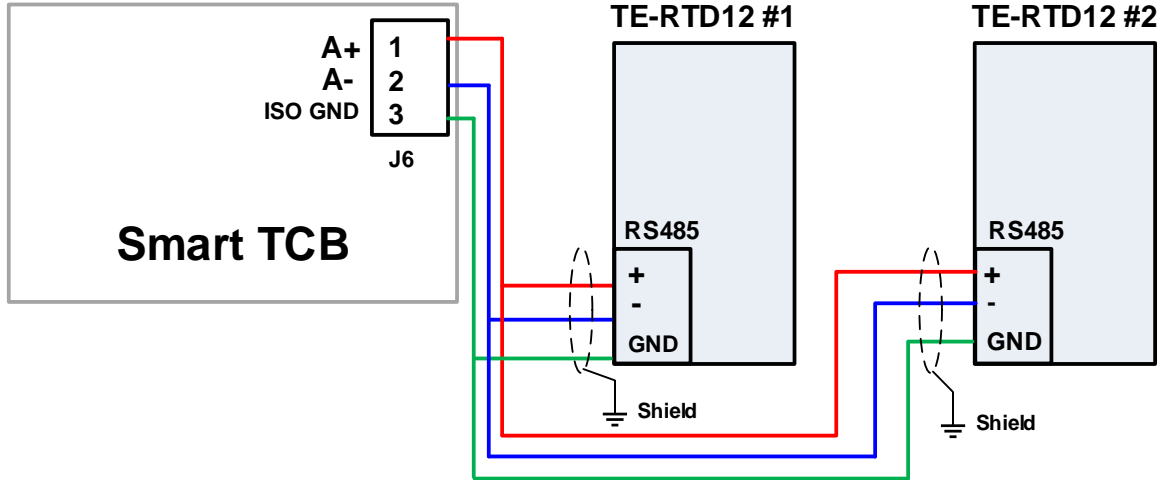

J6 Port:

RS485, 3 terminals, Non-isolated

Protocol: Modbus RTU

Device Address: Range 17 - 246.

Baud Rate: 19200

Pin 1 = S+, Pin 2 = S-, Pin 3 = GND

Note: Maximum number of TE-RTD12 units (Factory installed + Customer installed) is 2.

Communication Settings

Parameter	Description	Settings / Range	Default TE-RTD12 #1	Default TE-RTD12 #2
F102	Password	0 – 9999	2000	2000
F085	Communications	0 – 2 0=Disabled 1=Enabled (11 bit) communication only 2=Enabled (10 bit) comm. only	2	2
F086	Baud Rate	9.6, 19.2 and 38.4 kB Note: Msmart only supports 19.2 kB	19.2	19.2
F087	Modbus Address	1 - 247	17-246	17-246

3. Msmart Touch Screen

3.1 Startup

After connecting the Msmart touch screen to the Smart TCB and connecting the RX and TE-RTD12 devices the system can be powered up.

Upon power-up the Msmart will show a splash startup screen with a status bar indicating the Msmart startup status.

Next the Msmart touch screen will attempt to communicate with the MVC and additional devices. The online status is shown on the top of the screen. Green indicates device is communicating properly and red indicates communication cannot be established with the device.



Msmart Splash Screen

Msmart consist of a touchscreen and four membrane buttons for navigation that can be used when the system is installed in a harsh environment.

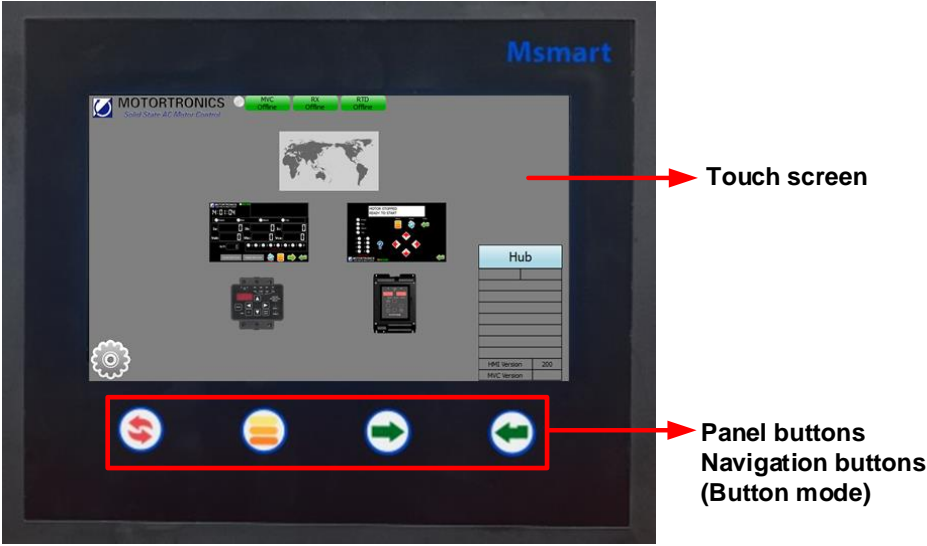

Msmart Touch Screen





Hardware Push Button Description		
Button		Resets the device on the screen only. Also resets the Msmart display by holding button for 6 – 10 sec.
		Switch between touchscreen and panel buttons (button mode). Menu icon will flash when panel buttons are active.
		Button used to move between selectable items on the touchscreen (forward Tab). The item will flash when selected.
		Select flashing item.

Table 2

3.2 Navigation and Settings

3.2.1 Main Menu

After powerup Msmart will display the main menu navigation screen. The main menu allows the users to monitor and program all devices connected to Msmart system.

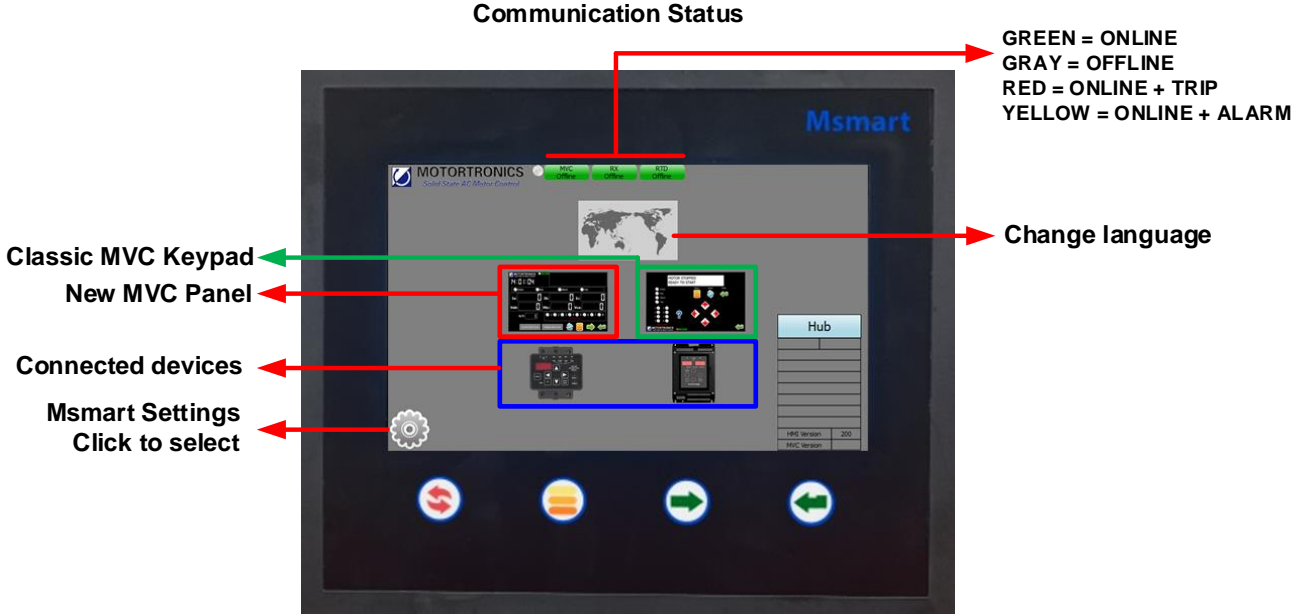

Note: The RX Motor Protection and TE-RTD12 are optional devices

Communication status

The communication status indicators at the top of the screen indicate if the Msmart is communicating successfully with the connected devices. Green means communication is ok, red for communication lost.

Communication Information

- Click to display specific information about
- Smart TCB communication connection.
 - RS232/RS422/RS485 communication

3.2.2 Main MVC Status / Setup Screen

The status screen shows current operation status and includes:

- Alarm and trip status
- Phase current and voltages
- Auxiliary relay status
- Starting curve for voltage and current
- MVC setpoint and metering page success

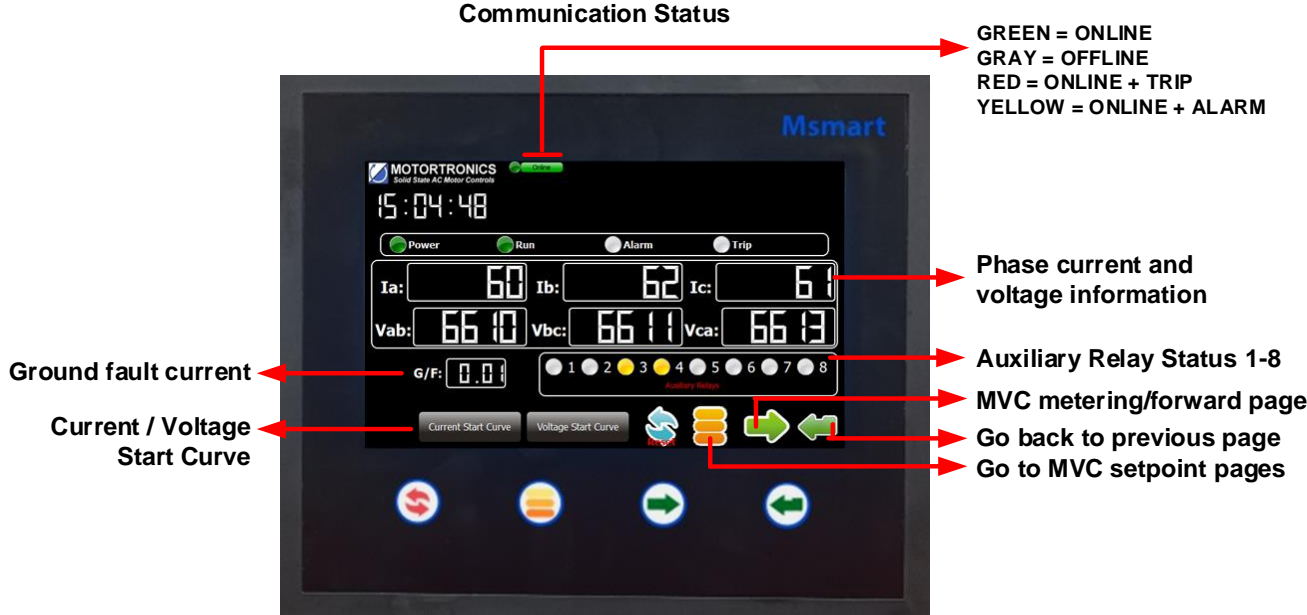

The MVC setpoint pages can be accessed by pressing the  button. See chapter MVC programming for more information.

The MVC metering pages can be accessed by pressing the  button. See chapter MVC metering for more information.

3.2.3 Msmart Settings

Click on the gear tooth icon  to view/change the Msmart touch screen settings.

The following settings can be adjusted:

- Main page background color
- Backlight brightness
- Beep sound
- Save delay time
- Return delay to main menu

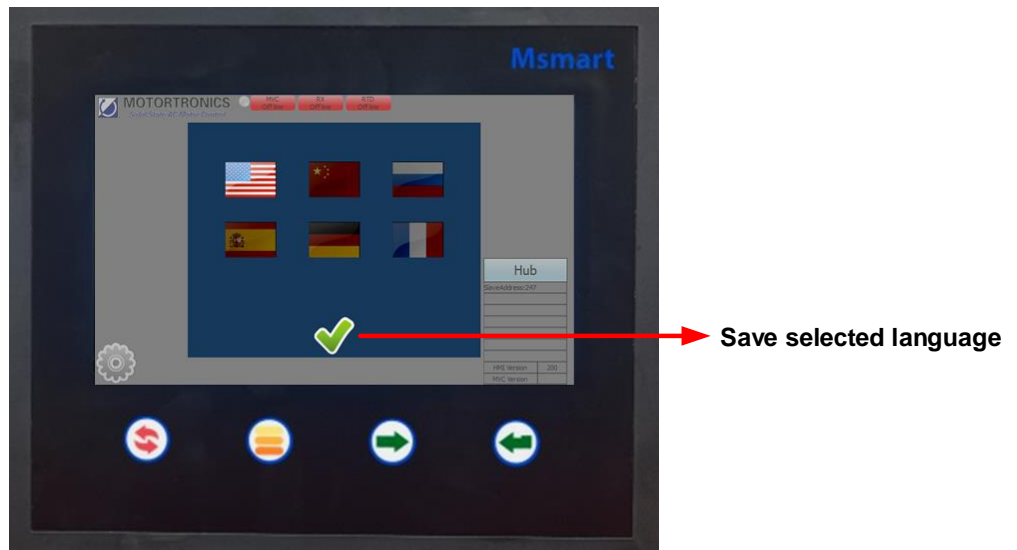
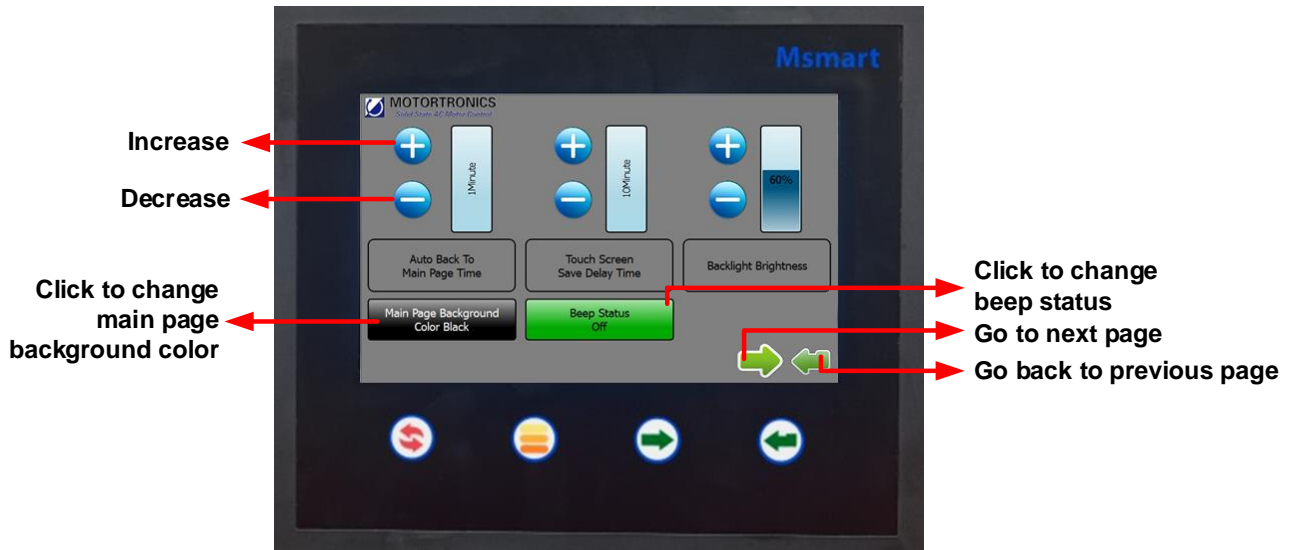

3.3 Device Selection and Programming

3.3.1 Device Selection

Depending on the Msmart system configuration all available devices will be displayed on the main menu page.

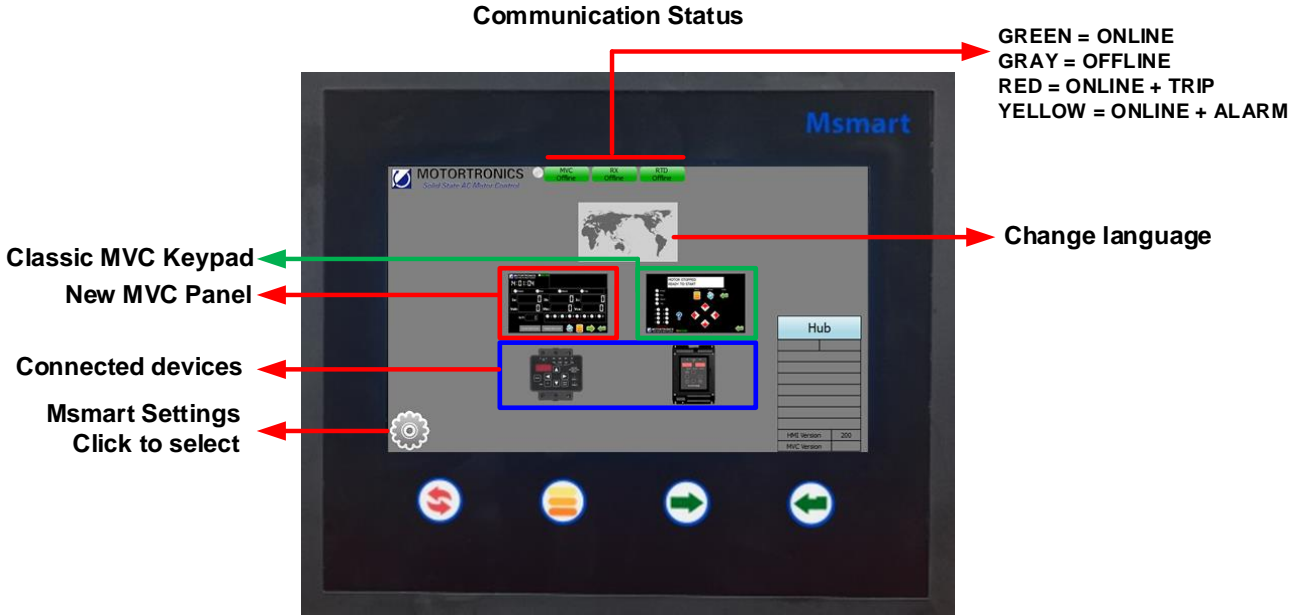

Navigation Keys (Button mode)

Use touch screen or dedicated keys on the Msmart touch screen to select device.

3.3.2 MVC4 Programming

The Msmart touch panel offers the user 2 way to program the MVC4 soft starter.

1. Use direct setpoint pages
2. Use Virtual MVC4 Keypad

#1: Access MVC Setpoint Pages Direct

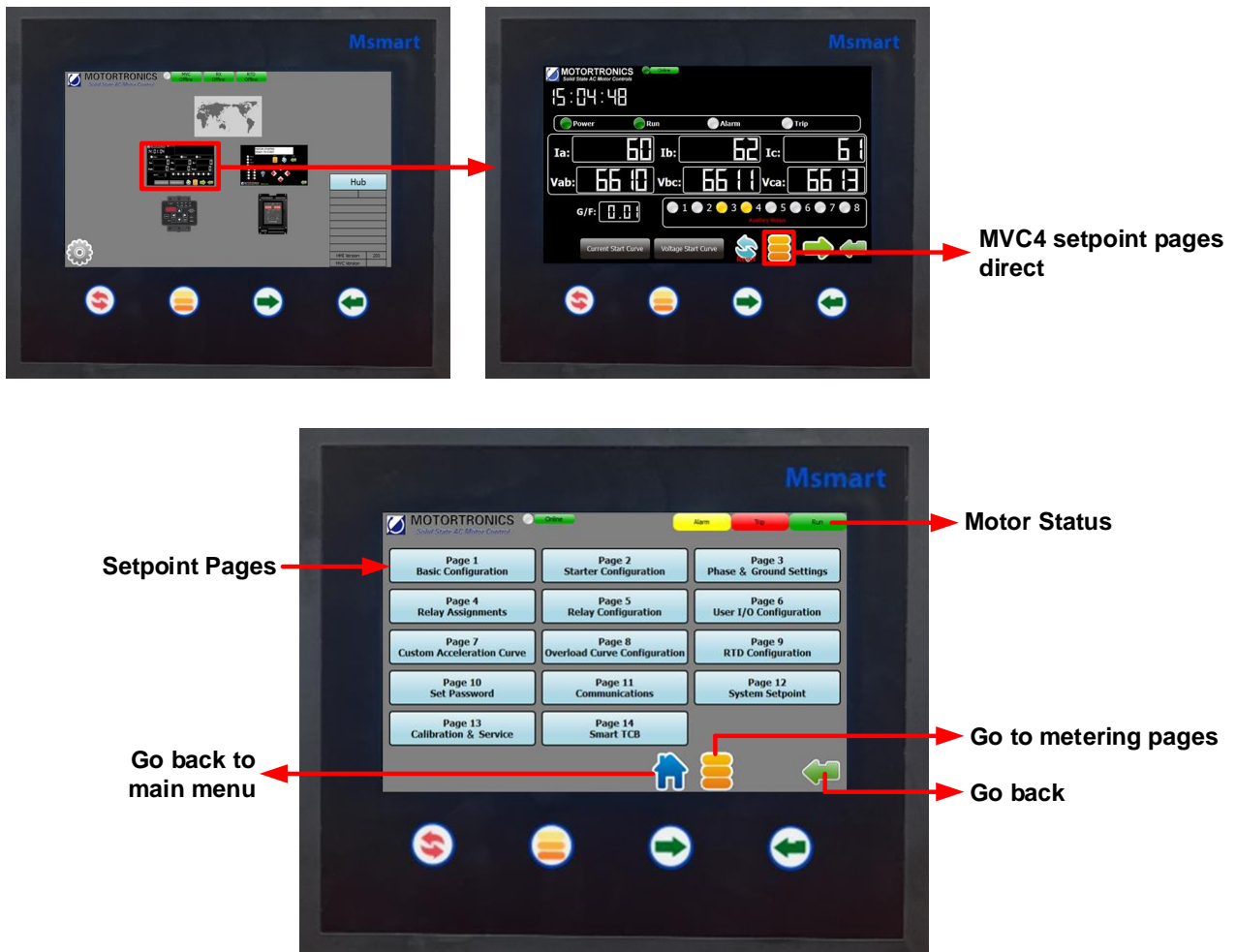

#1 Select setpoint page to view parameters direct

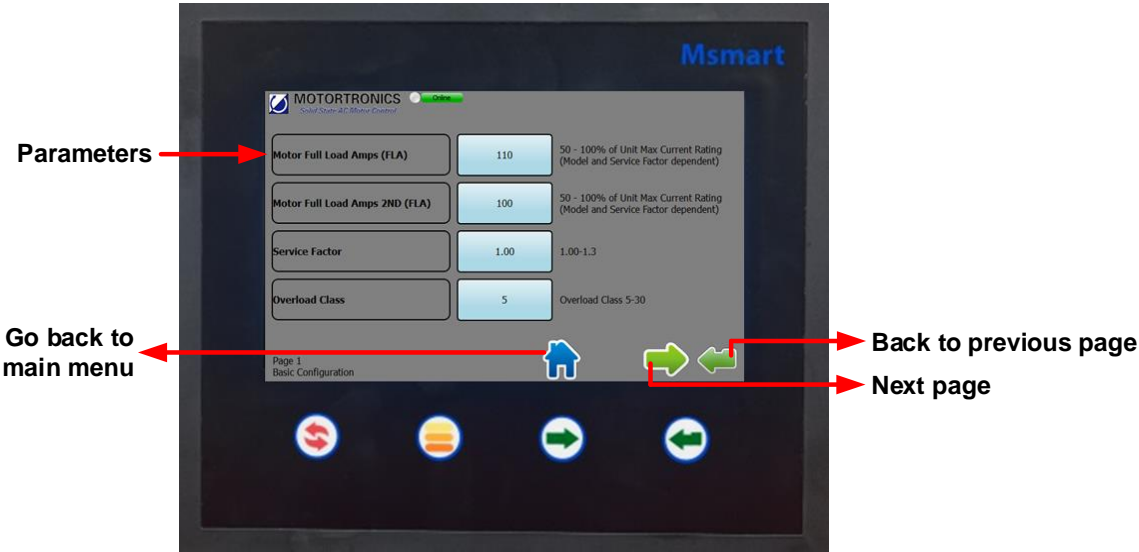

Change parameter settings

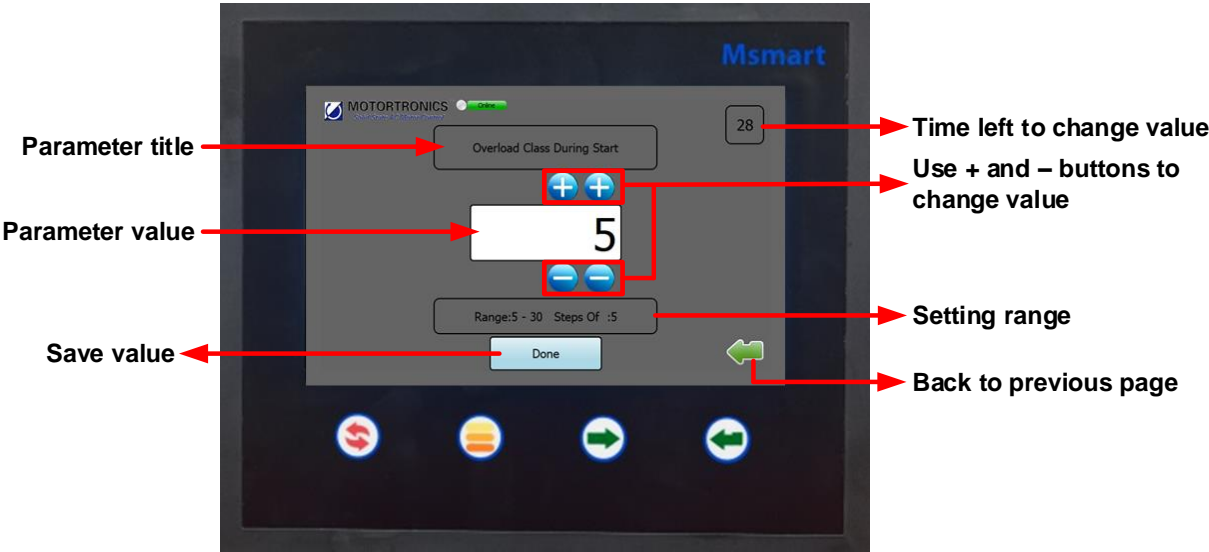

Click "done" button to save value

#2: Using the MVC4 Virtual Keypad

Click on the Classic MVC4 keypad in the Msmart main menu.

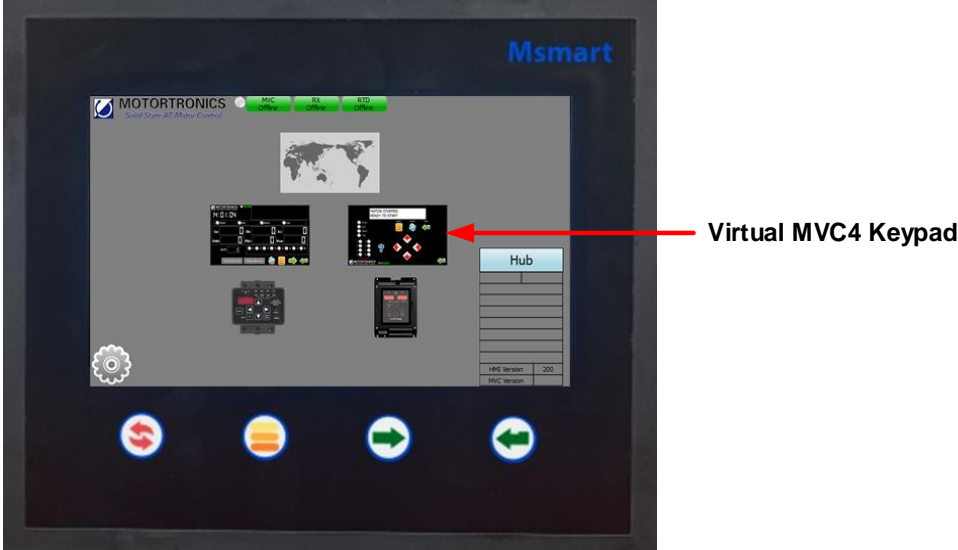

#2 Virtual MVC4 keypad

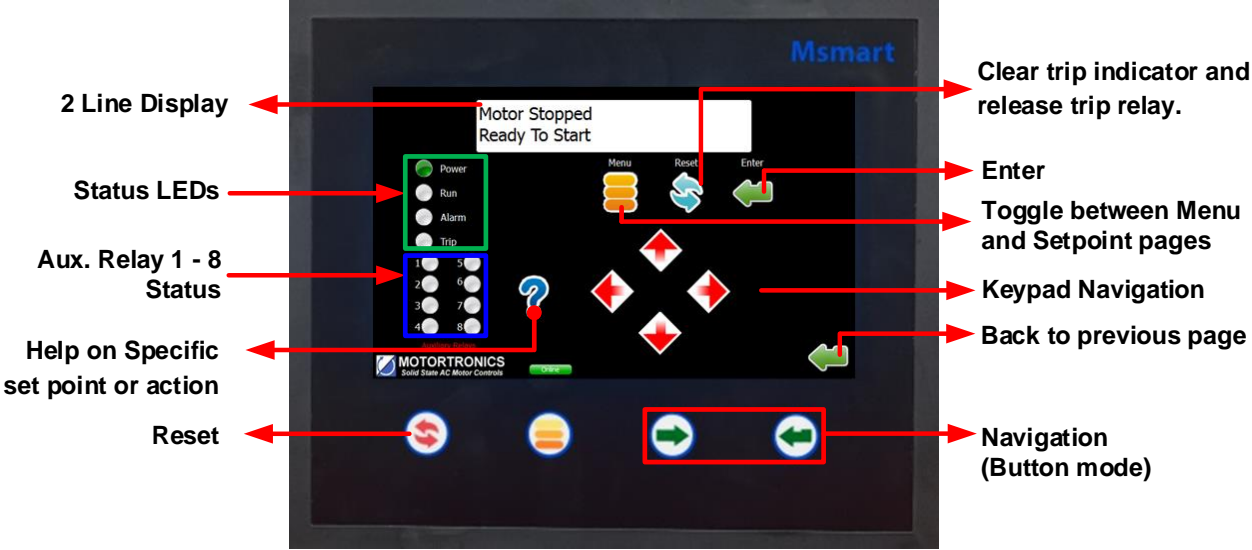

#2 Virtual Keypad/Operator Interface

The virtual keypad/ operator interface consists of:

- 2 rows of 20 characters
- 12 indicator LEDs
- 8 buttons

Note: The soft starter is menu driven and there are three levels of programming. The programming for two of these levels is password protected. Level two requires a three-digit password and level three requires a four-digit password.



Virtual Keypad Operator designations and functions

ITEM	DESIGNATION	DESCRIPTION
KEY	MENU	Toggle between the menu selection for metering and set point pages.
	RESET	Will clear the trip indicator and release the trip relay.
	ENTER	Pressing the ENTER button once enters the EDIT mode where set point values can be changed. An "Asterisk" will appear on the display to indicate it is in the edit mode. After a set point value is changed, pressing the ENTER button again will save the revised value to memory and the asterisk will go off indicating the change has been saved. When not in the edit mode, the ENTER pushbutton will toggle through the event indicator list (such as alarms or trips)
	HELP	Provides general help information about a specific set point or action.
	UP ARROW	Will scroll up through the set point and metering menu page. It will scroll to the top of the set point page or a section. In edit mode it will increase a set point in an incremental step or toggle through the available options in the set point.
	RIGHT ARROW	In the main menu the RIGHT ARROW button provides access to the set point page. For set point pages with multiple columns, the RIGHT ARROW will scroll the set point page to the right. When in edit mode it will shift one character to the right.
	DOWN ARROW	Will scroll down through the set point pages and down through the set points. In edit mode, it will decrement through values and toggle available options in the set point.
	LEFT ARROW	Will move to the left through set point pages with multiple columns. When in edit mode it will become the backspace key and will shift one character to the left.
LED	POWER	Indicates control power is present
	RUN	Indicates unit/motor is running
	ALARM	Lights in conjunction with Relay AUX 2 to indicate an Alarm event or warn of possible critical condition.
	TRIP	Lights in conjunction with Relay AUX 1 to indicate a Trip condition has occurred.
	AUX 1- 8	Auxiliary relays (Note: Relays 5-8 are available for customer use)

See MVC4 User Manual for details on faults, alarms, monitor and setpoint pages

3.3.3 RX Programming

Select on the RX unit in the Msmart main menu.



RX Status Overview

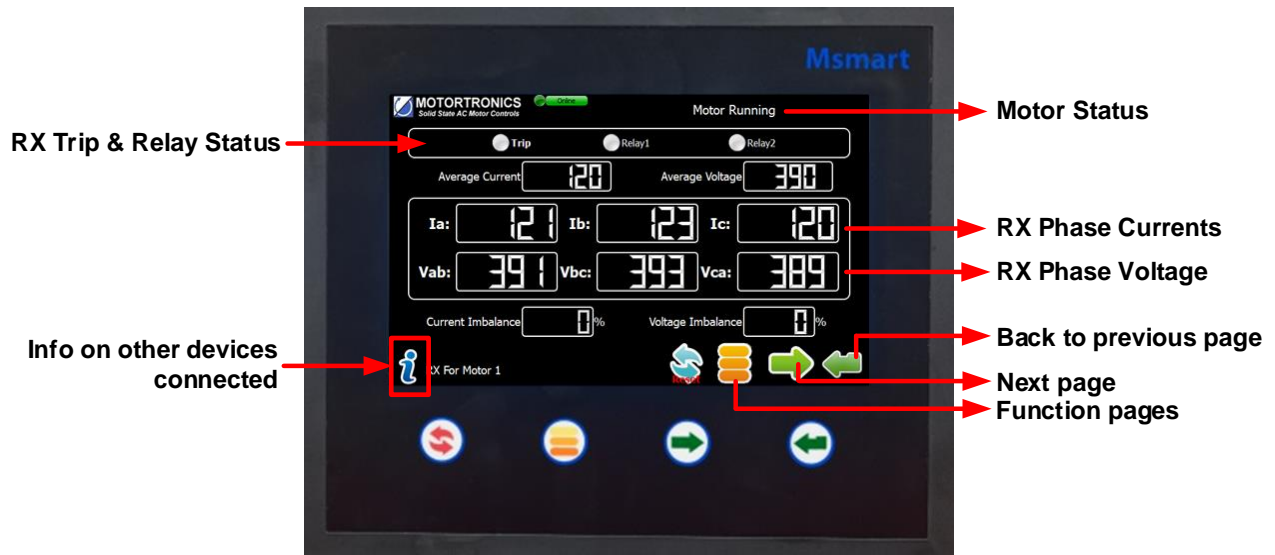

RX Function Pages



Select function page to view parameters

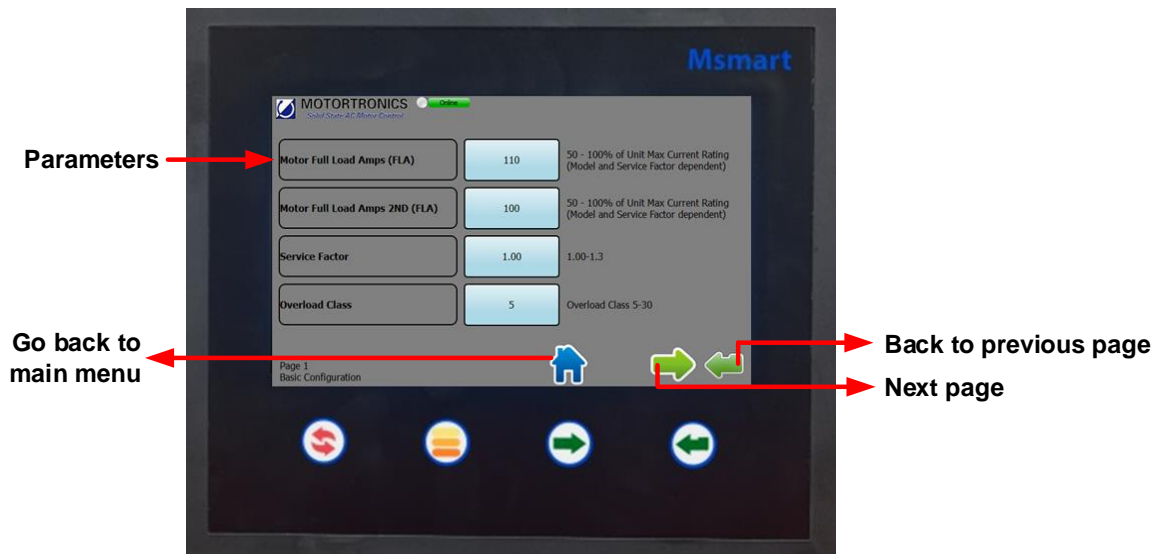

Changing parameter value

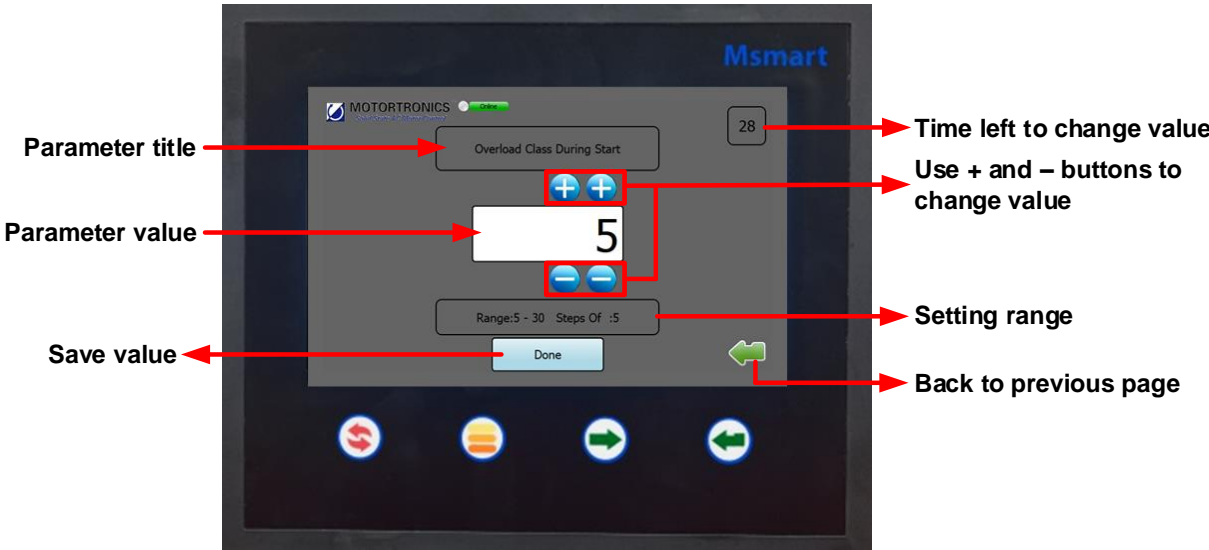

Click done to save value

RX Monitoring Pages

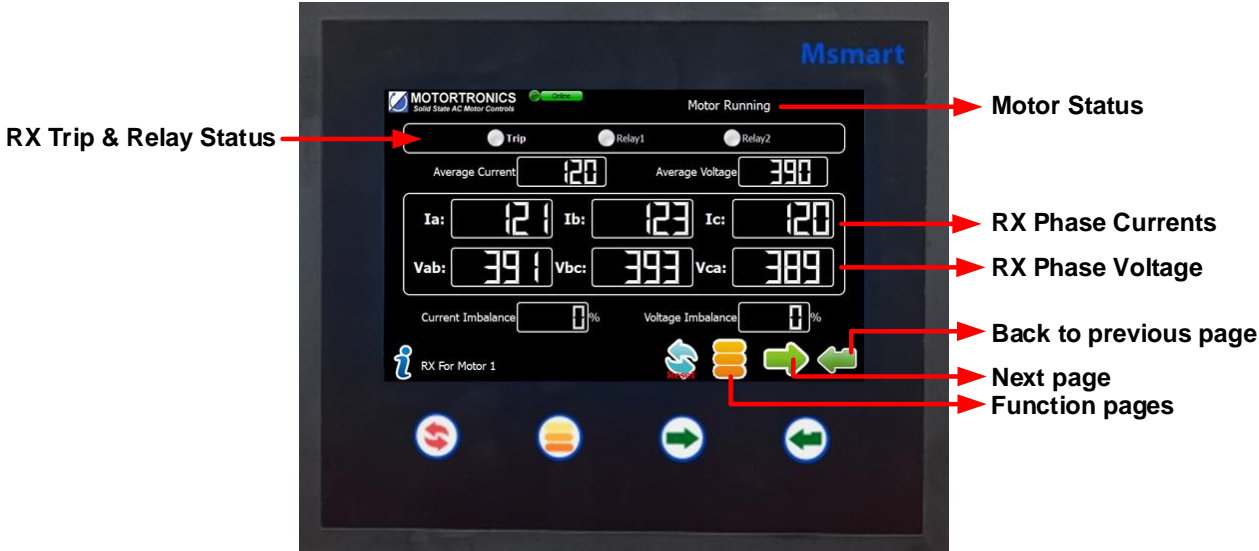

3.3.4 TE-RTD12 Programming

Select the TE-RTD12 keypad in the Msmart main menu.

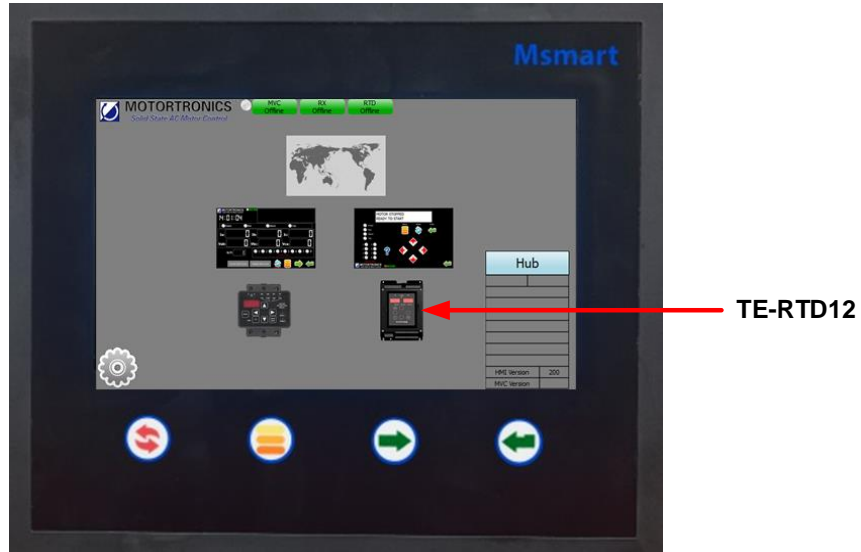

TE-RTD12 Status Overview

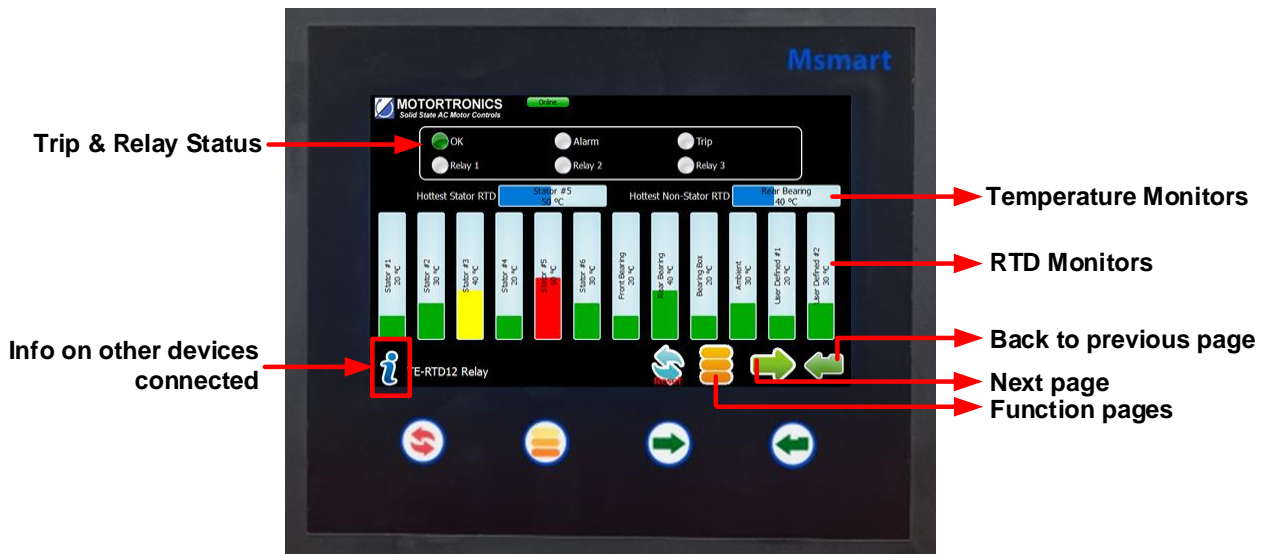

TE-RTD12 Function Pages

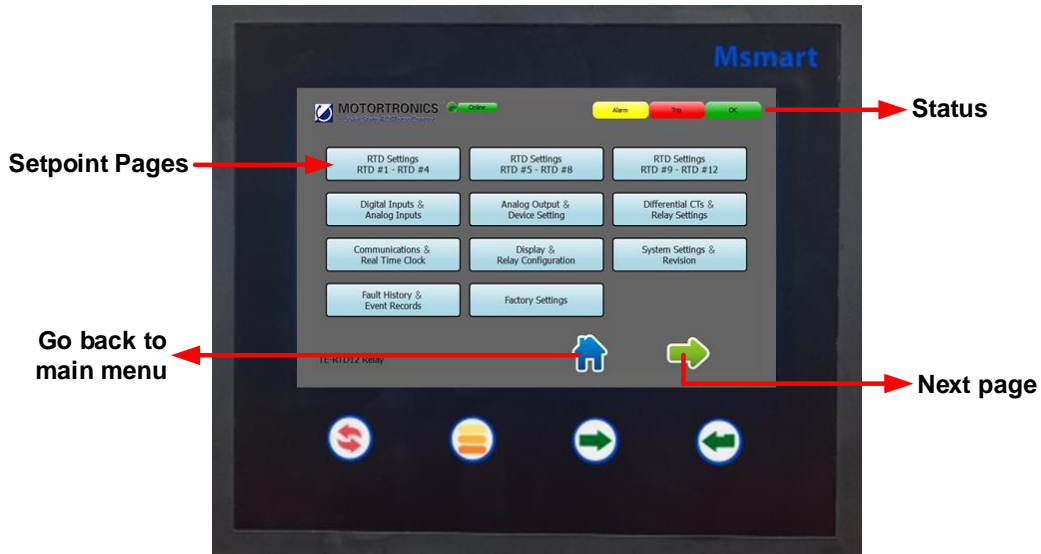

Select function page to view parameters

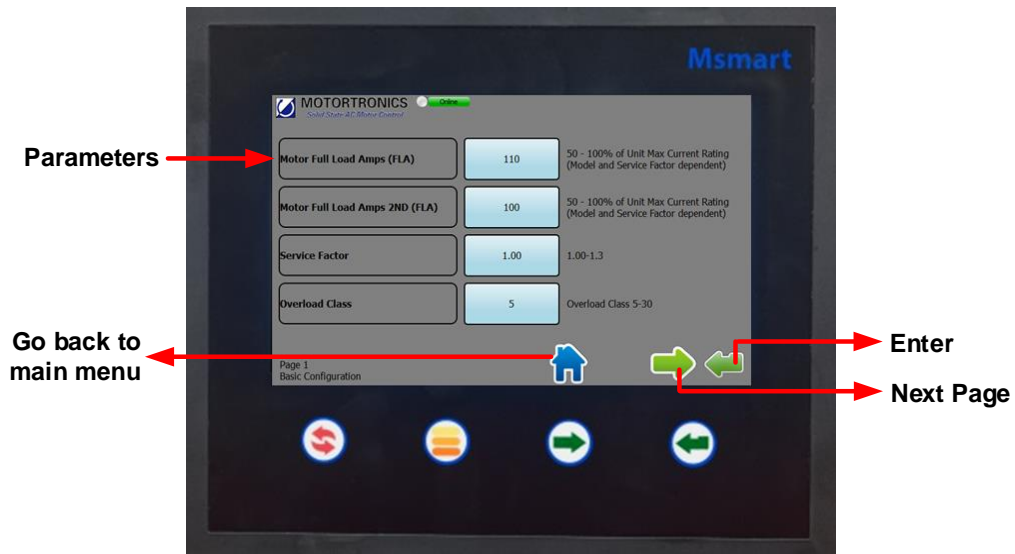

Changing parameter value

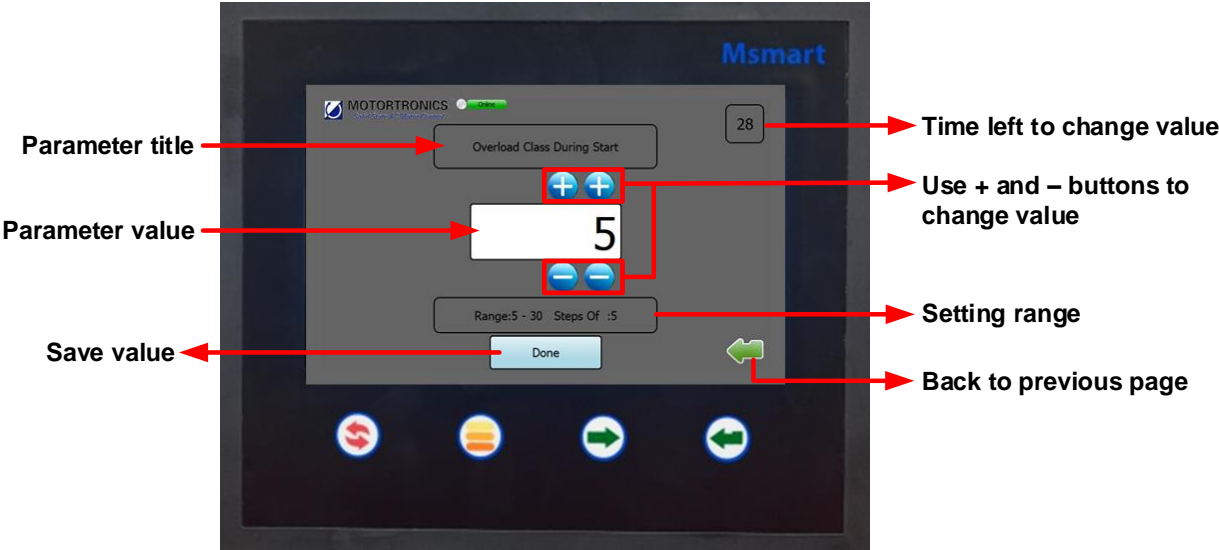

Click "done" button to save value

APPENDIX A: Technical Specifications

Screen Type:	Resistive Touch Screen
Keypad:	4 Membrane Keys
Input Voltage:	5VDC
Average Power Consumption:	3W
Real-time Clock:	Standard
Operating Design Temperature:	32°F – 122°F / 0°C to 50°C
Storage Temperature:	-4°F – 176°F / -20°C to 80°C
Ambient Conditions:	5% to 95% relative humidity 0 – 3300ft (1000m) elevation
Approval:	UR (Recognized component)

Warranty information

1 Year Warranty: Phasetronics Inc., dba Motortronics, (hereinafter “Company”) warrants the **Msmart** product to be free from defects in material and/or workmanship for a period of one (1) year from the date of sale, or a maximum of 18 months from the date of manufacture (if no sales records are available) as indicated by the unit’s date code. The Company reserves the right to repair or replace any malfunctioning units or sub- assemblies under warranty at the Company’ sole option. Warranty repairs may be performed at the Company’s facility, in the field by a factory-authorized technician, or by the customer only with prior approval and at the specific direction of the Company’s Technical Services personnel. During the 1 year period, malfunctions of the control boards will be dealt with by replacement of the Modular Control Assembly (MCA), which contains the User Interface Panel, Digital Control Unit, Bypass control (if any) and Communications Interface. The MCA is designed to be replaced quickly without the need for tools (plug-in), and as such will constitute the majority of warranty replacements.

Warranty Service Procedure:

In the event that warranty service becomes necessary, contact the distributor where the starter was purchased, or Motortronics Technical Services department directly at (727) 573-1819. Be prepared to provide the complete Model number, Serial Number, date and place of purchase. It is also helpful to know the date of initial commissioning. When Technical Services has determined the nature of the problem and that sending replacement parts or assemblies can repair it, they will require a purchase order for replacement parts and issue a Return Material Authorization (RMA) for the defective parts or assemblies. If any components or assemblies are received at the factory without the proper RMA documentation, the shipment(s) will be refused.

When the replacement parts are received and evaluated at the factory, any warranty determination will result in an offsetting credit being issued for the replacement parts already sent out. If the unit is not needed for immediate operation, an alternative is to have the Technical Services representative provide an RMA for the components, and they will be evaluated and repaired at the factory, and returned. In either circumstance, freight/shipping costs are the responsibility of the purchaser.

Responsibility:

Company is not responsible for the misuse or misapplication of its products, intentional or otherwise. Improper application, installation, failure to provide safety devices or protective measures, or operation above its ratings, and failure to properly maintain or service products are all beyond the control and responsibility of the Company. Under no circumstances shall the Company be liable for loss of profits, indirect, incidental, special, consequential or other similar damages arising out of the misuse, misapplication or failure to maintain the

California Customers:

California Proposition 65 Warning

WARNING: this product and associated accessories may contain chemicals known to the State of California to cause cancer, birth defects, or other reproductive harm. For more information visit <https://p65warnings.ca.gov>



MOTORTRONICS™

Solid State AC Motor Control

Msmart

MV addendum w/MVC4-TCB

Phasetronics, Inc. dba Motortronics
1600 Sunshine Drive
Clearwater, Florida 33765
USA

Tel: +1 727.573.1819 or 888.767.7792
Fax: +1 727.573.1803 or 800.548.4104

www.motortronics.com